

# CAPPADOCIA Tracklight



CAPPADOCIA, the powerful spotlight series with up to 4500lm fulfills even most demanding lighting requirements. Minimalistic features creates aesthetic look. The high quality converter housing and spotlight head are made of pressure-diecast aluminium. Classical Avolux segmented Miro Silver reflector with LOR 93% light efficiency used with CAPPADOCIA spotlights. Different accesories can be integrated to front ring enables architects to use this spotlight range in various different applications.

Yüksek aydınlatma gücüne sahip CAPPADOCIA armatür serisi 4500 lümene kadar ışık gücü sağlar. Minimal hatlar sayesinde estetik görünüm ürün serisine kazandırılmıştır. Yüksek Klasik %93 verimliliğe sahip Avolux Segmente Miro Silver reflektör teknolojisi sayesinde armatürün ışık kalitesi en üst düzeye ulaşır. Farklı aksesuar seçenekleri ile mimarlar ve aydınlatma danışmanları CAPPADOCIA ürün serisini farklı uygulamalarda rahatlıkla kullanabilmektedir.

## EN

- Die-cast aluminium body.
- Mains voltage: 220-240V / 50-60Hz.
- Clever thermal design with passive heat dissipation.
- With 3-phase universal track adaptor.
- 90° rotation on vertical and 350° angle on horizontal axis with mechanical aiming lock.
- Clear safety glass.
- Classic dimming systems of DALI and 1-10V Dim options.
- High tech control systems of Warm Dim and Wireless Dim options.
- Basic colours: White, Black, Gray, Dark Gray, RAL9010 and special color options.
- Available accesories are Honeycomb Filter, Colour Filter, Antiglare Screen and Visor.
- Spot, Medium and Flood beam angle options available with rotationally symmetric light distribution.
- Standart CRI>80, high CRI>90 and super high CRI>98 LED options available.
- Up to 142lm/W efficiency.
- High colour consistency: <3 SDCM

## TR

- Alüminyum enjeksiyon gövde.
- 220-240V / 50-60Hz enerji girişli.
- Pasif soğutma teknolojisine sahip akıllı soğutma tasarımı.
- 3-Fazlı üniversal ray adaptörlü.
- Dikeyde 90°, yatayda 350° hareket kabiliyetine sahip mekanik kilitlemeli mafsalsistemi.
- Tamperli cam.
- Klasik DALI ve 1-10V DIM seçenekleri uygulanabilir.
- Yüksek teknoloji kontrol sistemleri olan Kablosuz DIM ve Sıcak DIM uygulamaları yapılabilir.
- Standart renk seçenekleri: Beyaz, Siyah, Gri, Koyu Gri, RAL9010 yanında isteğe bağlı özel renk seçenekleri uygulanabilir.
- Balpeteği Filtresi, Renk Filtresi, Kamaşma Önleyici ve Vizör aksesuar seçenekleri uygulanabilir.
- Dar, Orta ve Geniş reflektör açısı seçenekleri mevcuttur.
- Standart CRI>80, yüksek CRI>90 ve ekstra yüksek CRI>98 LED seçenekleri mevcuttur.
- 142lm/W'a varan verim.
- Yüksek renk uyumu: <3 SDCM



# Cappadocia



Cappadocia Maxi

Cappadocia Mini

Cappadocia Maxi Deco

Cappadocia Mini Deco

Cappadocia Maxi Zigzag

## Beam Angles / Işık Açıları



20° - Spot

30° - Medium

40° - Flood

24° - Spot

36° - Medium

We use Segmented Miro Silver technology in Cappadocia. Efficiency rating of LOR >93% provides high lumen output. Spot, Medium and Flood options available with Miro-4 and Miro-8 surface.

Cappadocia serimizde segmente Miro Silver teknolojisine sahip reflektörler kullanılmaktadır. Kullandığımız reflektörlerin verimi LOR>93% seviyesinde olup armatür verimini en üst seviyeye çıkarmaktadır. Dar, Orta ve Geniş açı seçenekleri bulunmakta olup Miro-4 ve Miro-8 yüzey seçenekleri bulunmaktadır.

## Wireless DIM / Kablosuz DIM

Avolux offers wireless DIM control on its Cappadocia range that provides easy control and saves time on wiring during installation.

Avolux Cappadocia serisinde kablosuz DIM seçeneği sunarak kolay kontrol olanağı sunar. Ürün montaj kurulum esnasında daha az kablolama ile zamandan tasarruf sağlar.





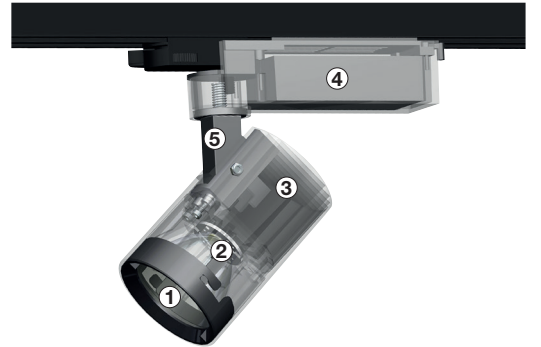

## Features / Özellikler

- 1- High efficient reflector optic with spot, medium and wide distribution options.  
Dar, orta ve geniş açı ışık dağılımlarına sahip yüksek verimli reflektör optik.
- 2- Highest efficiency COB led's with 2700K, 3000K, 3500K, 4000K and 5000K CCT options.  
2700K, 3000K, 3500K, 4000K ve 5000K renklere sahip yüksek verimli COB LED modül.
- 3- Clever design internal cooling fins. No visibility of cooling fins from outside.  
İç Soğutma kanallarına sahip akıllı soğutma tasarımı. Dışardan soğutma kanalları gözükmemektedir.
- 4- High quality LED driver that can function in high Ta conditions with five years warranty.  
Yüksek Ta değerlerinde çalışabilen yüksek kalite LED trafosu.
- 5- 90° vertical and 350° horizontal adjustable mounting arm with mechanical lock system.  
Dikeyde 90°, yatayda 350° hareket edebilir mekanik kilitleme sistemine sahip montaj kolu.













# Cappadocia

## DIM Options / DIM seçenekleri

						
		Cappadocia Maxi	Cappadocia Mini	Cappadocia Maxi Deco	Cappadocia Mini Deco	Cappadocia Maxi Zigzag
ON-OFF		•	•	•	•	•
PHASE CUT DIM / FAZ DIM	Ext.Code / Kod: .PH					
1-10V DIM	Ext.Code / Kod: .VO	•	•			•
DALI DIM	Ext.Code / Kod: .DA	•	•	•	•	•
WIRELESS DIM / KABLOSUZ DİM	Ext.Code / Kod: .WD			•	•	
WARM DIM / SICAK DİM	Ext.Code / Kod: .WM	•	•	•	•	•
TUNABLE WHITE / DİNAMİK BEYAZ	Ext.Code / Kod: .TW			•	•	

## Accessories / Aksesuarlar

						
		Cappadocia Maxi	Cappadocia Mini	Cappadocia Maxi Deco	Cappadocia Mini Deco	Cappadocia Maxi Zigzag
Colour Filter / Renkli Filtre	Ext.Code / Kod: .CLF	•	•	•	•	•
						
Antiglare Screen / Kamaşma Önleyici	Ext.Code / Kod: .VKO	•	•	•	•	•
						
Visor / Işık Siperi	Ext.Code / Kod: .VIS	•	•	•	•	•
						
Honeycomb Filter / Petekli Filtre	Ext.Code / Kod: .VBP	•	•	•	•	•
						
Barn Door / Yönlendirici Flap	Ext.Code / Kod: .VFL					
						

## Warm DIM / Sıcak DIM

Warm dimming technology allows a colour temperature gradual reduction from 3000K to 1800K, allowing soft and natural passage to different warm light conditions.

Sıcak DIM teknolojisi 3000K'den 1800K'e kademeli ve yumuşak sıcak ışık geçişi sağlar.



# Cappadocia Maxi

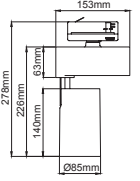

In Dali dimmable version, size/shape of the driver box changes.

Dali dim versiyonunda trafo kutusu şekil ve boyutları değişmektedir.



## 5 / Product Color / Ürün Renk

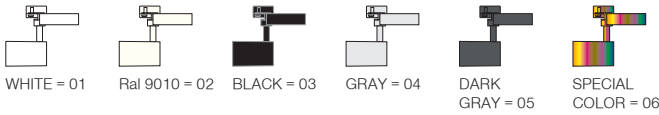

## Technical Drawing / Teknik Çizim

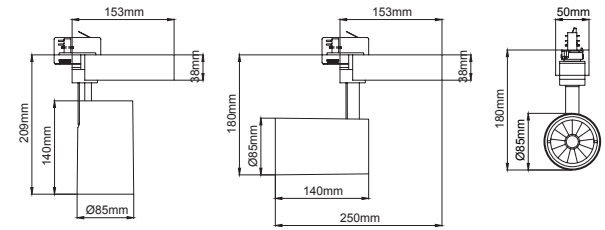

## Cappadocia Maxi / I01.MLT.26160



\* Code example / Kod örneği:  
I01.MLT.26160 . 35 . 827 . SP . 01

- 1- Product code / Armatür kodu
- 2- Power / Güç
- 3- CRI / Kelvin
- 4- Reflector angle / Reflektör açısı
- 5- Colour / Ürün renk

Power / Güç	CRI	Order Code / Sipariş Kodu	Kelvin	Lümen T <sub>c</sub> =50° Lümen
35W	CRI>80	I01.MLT.26160 . (.) . (...) . (.) . (.)	2700K	4174
			3000K	4288
			3500K	4428
			4000K	4582
			5000K	4902
			5000K	X
	CRI>90	I01.MLT.26160 . (.) . (...) . (.) . (.)	2700K	3751
			3000K	3844
			3500K	3978
			4000K	4257
			5000K	X
			5000K	X
CRI>98	I01.MLT.26160 . (.) . (...) . (.) . (.)	2700K	2796	
		3000K	2988	
		4000K	3135	
		1800K	2402	
		2400K	2497	
		6600K	3295	
Meat / Et COB	I01.MLT.26160 . (.) . (...) . (.) . (.)	1800K	2402	
Food / Gıda COB	I01.MLT.26160 . (.) . (...) . (.) . (.)	2400K	2497	
FISH / Balık COB	I01.MLT.26160 . (.) . (...) . (.) . (.)	6600K	3295	

2	Watt - Driving Current / Watt - Sürüş Akımı	3	CRI / Kelvin	4	Reflector Angle / Reflektör Açısı	5	Product Color / Ürün Renk		
35	35W - 900mA	827	CRI>80 - 2700K	9827	CRI>98 - 2700K	SP	20° - Spot	01	white
31	31W - 800mA	830	CRI>80 - 3000K	9830	CRI>98 - 3000K	ME	35° - Medium	02	ral 9010
28	28W - 700mA	835	CRI>80 - 3500K	9840	CRI>98 - 4000K	FL	45° - Flood	03	black
24	24W - 600mA	840	CRI>80 - 4000K	MEAT	1800K	See page 158 for ldt files. / Işık eğrileri için sayfa 158 bakınız.			
		850	CRI>80 - 5000K	GOLD	2400K				
		927	CRI>90 - 2700K	FISH	6600K				
		930	CRI>90 - 3000K						
		935	CRI>90 - 3500K						
		940	CRI>90 - 4000K			04	gray		
						05	dark gray		
						06	special color		

# Cappadocia Maxi Deco



COB Led Tracklight Series / COB Led Rayspot Serisi

## 5 / Product Color / Ürün Renk

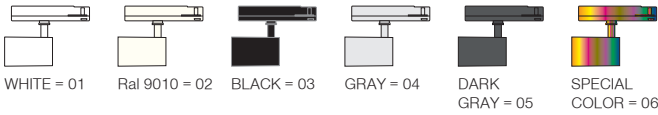

## Technical Drawing / Teknik Çizim

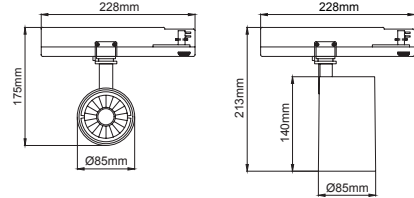

## Cappadocia Maxi Deco / I01.MLT.26165



\* Code example / Kod örneği:

I01.MLT.26165 . 35 . 827 . SP . 01

- 1- Product code / Armatür kodu
- 2- Power / Güç
- 3- CRI / Kelvin
- 4- Reflector angle / Reflektör açısı
- 5- Colour / Ürün renk

Power / Güç	CRI	Order Code / Sipariş Kodu	Kelvin	Lümen T <sub>c</sub> =50° Lümen	
35W	CRI>80	I01.MLT.26165 . (...) . (...) . (...) . (...)	2700K	4174	
			3000K	4288	
			3500K	4428	
			4000K	4582	
			5000K	4902	
	CRI>90	I01.MLT.26165 . (...) . (...) . (...) . (...)	2700K	3751	
			3000K	3844	
			3500K	3978	
			4000K	4257	
			5000K	X	
CRI>98	I01.MLT.26165 . (...) . (...) . (...) . (...)	2700K	2881		
		3000K	2986		
		4000K	3135		
		Meat / Et COB	I01.MLT.26165 . (...) . (...) . (...) . (...)	1800K	2420
		Food / Gıda COB	I01.MLT.26165 . (...) . (...) . (...) . (...)	2400K	2497
FISH / Balık COB	I01.MLT.26165 . (...) . (...) . (...) . (...)	6600K	3295		

Complete Code / Komple Kod	2	3	4	5	
	Watt - Driving Current / Watt - Sürüş Akımı	CRI / Kelvin	Reflector Angle / Reflektör Açısı	Product Color / Ürün Renk	
I01.MLT.26165 . (...) . (...) . (...) . (...)	35 35W - 900mA	827 CRI>80 - 2700K	SP 20° - Spot	01 white	
	31 31W - 800mA	830 CRI>80 - 3000K	ME 35° - Medium	02 ral 9010	
	28 28W - 700mA	835 CRI>80 - 3500K	FL 45° - Flood	03 black	
	24 24W - 600mA	840 CRI>80 - 4000K	MEAT 1800K	See page 158 for ldt files. / Işık eğrileri için sayfa 158 bakınız.	04 gray
		850 CRI>80 - 5000K	GOLD 2400K		05 dark gray
		927 CRI>90 - 2700K	FISH 6600K		06 special color
		930 CRI>90 - 3000K			
		935 CRI>90 - 3500K			
		940 CRI>90 - 4000K			

# Cappadocia Mini

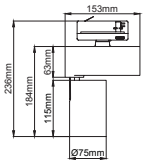

In Dali dimmable version, size/shape of the driver box changes.

Dali dim versiyonunda trafo kutusu şekil ve boyutları değişmektedir.



## 5 / Product Color / Ürün Renk

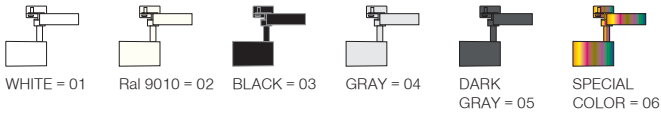

## Technical Drawing / Teknik Çizim

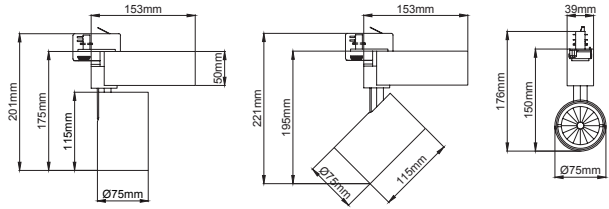

## Cappadocia Mini / I01.MLT.16160



\* Code example / Kod örneği:  
I01.MLT.16160 . 28 . 827 . ME . 01

- 1- Product code / Armatür kodu
- 2- Power / Güç
- 3- CRI / Kelvin
- 4- Reflector angle / Reflektör açısı
- 5- Colour / Ürün renk

Power / Güç	CRI	Order Code / Sipariş Kodu	Kelvin	Lümen T <sub>C</sub> =50° Lümen		
28W	CRI>80	I01.MLT.16160 . (..) . (...) . (..) . (..)	2700K	3479		
			3000K	3633		
			3500K	3674		
			4000K	3815		
			5000K	4079		
			2700K	2816		
	CRI>90	I01.MLT.16160 . (..) . (...) . (..) . (..)	3000K	3110		
			3500K	3193		
			4000K	3228		
			5000K	X		
			CRI>98	I01.MLT.16160 . (..) . (...) . (..) . (..)	2700K	2543
					3000K	2635
4000K	2822					
Meat / Et COB	I01.MLT.16160 . (..) . (...) . (..) . (..)	1800K	X			
Food / Gıda COB	I01.MLT.16160 . (..) . (...) . (..) . (..)	2400K	X			
FISH / Balık COB	I01.MLT.16160 . (..) . (...) . (..) . (..)	6600K	X			

2	Watt - Driving Current / Watt - Sürüş Akımı	3	CRI / Kelvin		4	Reflector Angle / Reflektör Açısı	5	Product Color / Ürün Renk		
Complete Code / Komple Kod	28	28W - 700mA	827	CRI>80 - 2700K	9827	CRI>98 - 2700K	SP	23° - Spot	01	white
	24	24W - 600mA	830	CRI>80 - 3000K	9830	CRI>98 - 3000K	ME	35° - Medium	02	ral 9010
	20	20W - 500mA	835	CRI>80 - 3500K	9840	CRI>98 - 4000K	FL	48° - Flood	03	black
	15	15W - 350mA	840	CRI>80 - 4000K					04	gray
			850	CRI>80 - 5000K					05	dark gray
			927	CRI>90 - 2700K					06	special color
			930	CRI>90 - 3000K						
			935	CRI>90 - 3500K						
			940	CRI>90 - 4000K						

See page 160 for ldt files. / Işık eğrileri için sayfa 160 bakınız.

# Cappadocia Mini Deco



COB Led Tracklight Series / COB Led Recessed Series

## 4 / Product Color / Ürün Renk

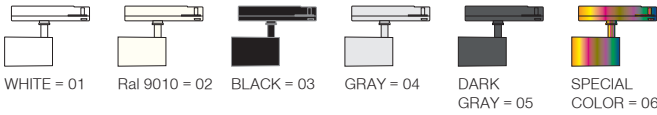

## Technical Drawing / Teknik Çizim

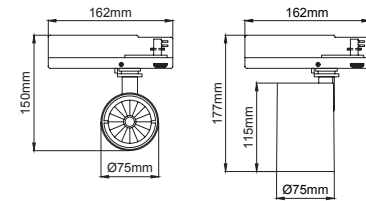

## Cappadocia Mini Deco / I01.MLT.16165



\* Code example / Kod örneği:

I01.MLT.16165 . 28 . 827 . ME . 01

- 1- Product code / Armatür kodu
- 2- Power / Güç
- 3- CRI / Kelvin
- 4- Reflector angle / Reflektör açısı
- 5- Colour / Ürün renk

Power / Güç	CRI	Order Code / Sipariş Kodu	Kelvin	Lümen T <sub>c</sub> =50° Lümen
28W	CRI>80	I01.MLT.16165 . (..) . (...) . (..) . (..)	2700K	3479
			3000K	3633
			3500K	3674
			4000K	3815
			5000K	4079
			5000K	X
	CRI>90	I01.MLT.16165 . (..) . (...) . (..) . (..)	2700K	2816
			3000K	3110
			3500K	3193
			4000K	3228
			5000K	X
			5000K	X
CRI>98	I01.MLT.16165 . (..) . (...) . (..) . (..)	2700K	2543	
		3000K	2635	
		4000K	2822	
		1800K	X	
		2400K	X	
		6600K	X	
Meat / Et COB	I01.MLT.16165 . (..) . (...) . (..) . (..)	1800K	X	
Food / Gıda COB	I01.MLT.16165 . (..) . (...) . (..) . (..)	2400K	X	
FISH / Balık COB	I01.MLT.16165 . (..) . (...) . (..) . (..)	6600K	X	

Complete Code / Komple Kod	2	3	4	5	
	Watt - Driving Current / Watt - Sürüş Akımı	CRI / Kelvin	Reflector Angle / Reflektör Açısı	Product Color / Ürün Renk	
	28 28W - 700mA	827 CRI>80 - 2700K	SP 23° - Spot	01 white	
	24 24W - 600mA	830 CRI>80 - 3000K	ME 35° - Medium	02 ral 9010	
	20 20W - 500mA	835 CRI>80 - 3500K	FL 48° - Flood	03 black	
	15 15W - 350mA	840 CRI>80 - 4000K	9840 CRI>98 - 4000K	See page 160 for ldt files. / Işık eğrileri için sayfa 160 bakınız.	04 gray
		850 CRI>80 - 5000K			05 dark gray
		927 CRI>90 - 2700K			06 special color
		930 CRI>90 - 3000K			
		935 CRI>90 - 3500K			
		940 CRI>90 - 4000K			



# Cappadocia Maxi Zigzag

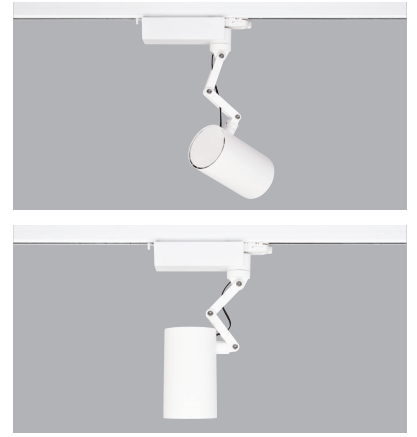

## 5 / Product Color / Ürün Renk

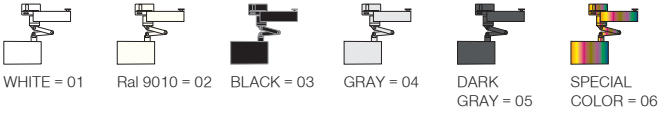

## Technical Drawing / Teknik Çizim

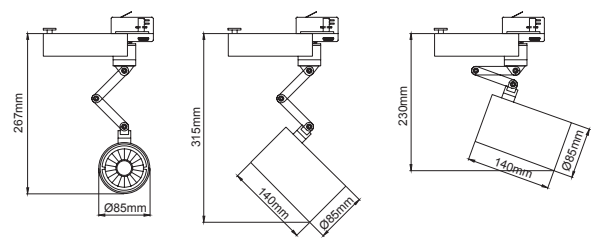

## Cappadocia Maxi Zigzag / I01.MLT.26170



\* Code example / Kod örneği:  
I01.MLT.26170 . 35 . 827 . SP . 01

- 1- Product code / Armatür kodu
- 2- Power / Güç
- 3- CRI / Kelvin
- 4- Reflector angle / Reflektör açısı
- 5- Colour / Ürün renk

Power / Güç	CRI	Order Code / Sipariş Kodu	Kelvin	Lümen T <sub>c</sub> =50° Lümen
35W	CRI>80	I01.MLT.26170 . (..) . (...) . (..) . (..)	2700K	4174
			3000K	4288
			3500K	4428
			4000K	4582
			5000K	4902
			5000K	X
	CRI>90	I01.MLT.26170 . (..) . (...) . (..) . (..)	2700K	3751
			3000K	3844
			3500K	3978
			4000K	4257
			5000K	X
			5000K	X
CRI>98	I01.MLT.26170 . (..) . (...) . (..) . (..)	2700K	2796	
		3000K	2988	
		4000K	3135	
		1800K	2420	
		2400K	2497	
		6600K	3295	
Meat / Et COB	I01.MLT.26170 . (..) . (...) . (..) . (..)	1800K	2420	
Food / Gıda COB	I01.MLT.26170 . (..) . (...) . (..) . (..)	2400K	2497	
FISH / Balık COB	I01.MLT.26170 . (..) . (...) . (..) . (..)	6600K	3295	

2	Watt - Driving Current / Watt - Sürüş Akımı	3	CRI / Kelvin	4	Reflector Angle / Reflektör Açısı	5	Product Color / Ürün Renk		
35	35W - 900mA	827	CRI>80 - 2700K	9827	CRI>98 - 2700K	SP	20° - Spot	01	white
31	31W - 800mA	830	CRI>80 - 3000K	9830	CRI>98 - 3000K	ME	35° - Medium	02	ral 9010
28	28W - 700mA	835	CRI>80 - 3500K	9840	CRI>98 - 4000K	FL	45° - Flood	03	black
24	24W - 600mA	840	CRI>80 - 4000K	MEAT	1800K	See page 158 for ldt files. / Işık eğrileri için sayfa 158 bakınız.			
		850	CRI>80 - 5000K	GOLD	2400K				
		927	CRI>90 - 2700K	FISH	6600K				
		930	CRI>90 - 3000K						
		935	CRI>90 - 3500K						
		940	CRI>90 - 4000K						
						04	gray		
						05	dark gray		
						06	special color		

# Cappadocia Maxi Zigzag

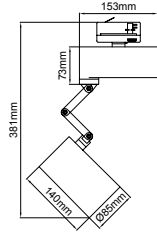

In Dali dimmable version, size/shape of the driver box changes.

Dali dim versiyonunda trafo kutusu şekil ve boyutları değişmektedir.

Thanks to its special design bracket system, Cappadocia Maxi Zigzag maximizes the flexibility of directing the lightsource including upward illumination. Can be used in many different applications including cove lighting, indirect track lighting applications etc.

Özel tasarım mafsal sistemi sayesinde, Cappadocia Maxi Zigzag ışık kaynağının yukarı yöne dahil birçok farklı şekilde yönlendirilmesini olanaklı kılar. Kanal içi ray spot, endirekt ray üzeri aydınlatma gibi birçok farklı uygulamalarda tercih edilir.

